

DRAWING NUMBER:	09-9012-1-XXXX
PRODUCT GROUP:	PC JACKS
SUB-GROUP:	INSULATED PC JACKS
DESCRIPTION:	PC JACK - PTFE INSULATED

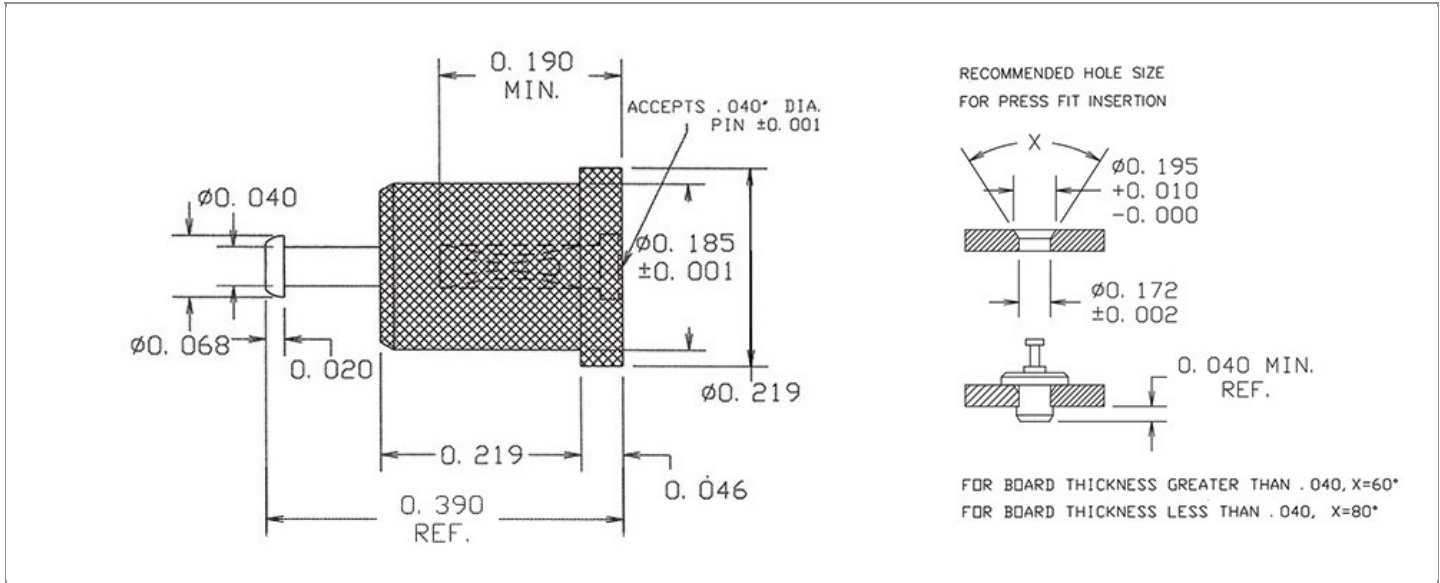

ACCEPTS PIN / PLUG / JACK SIZE	OVERALL LENGTH	MIN. HOLE DEPTH	MOUNTING ORIENTATION
0.040" ± 0.001	0.390"	0.190"	VERTICAL
BOARD / PANEL MOUNTING METHOD	MOUNTING HOLE SIZE	BOARD / PANEL THICKNESS	FEED THRU COMBINATION
PRESS FIT	0.172" ± 0.002	1/32" - 3/16"	JACK/TURRET

PART NO. STRUCTURE:

09-9012	-	1	-	XX	XX
PART SERIES		DIMENSION		FINISH	INSULATION COLOR

MATERIAL OPTIONS:

09-9012-1-XXXX

COMPONENT	MATERIAL	MATERIAL AND SPECIFICATION
BODY	BRASS	BRASS PER ASTM B16, ALLOY C36000, 1/2 HARD
SPRING (CAGE)	BERYLLIUM COPPER	BERYLLIUM COPPER PER ASTM B194, ALLOY C17200
INSULATION*	PTFE	PTFE PER ASTM D1710
MOUNTING BRACKET	N/A	N/A

*For Insulation color, please see INSULATION COLOR OPTIONS on Page 2

FINISH - PLATING OPTIONS:

09-9012-1-XXXX

FINISH CODE	COMPONENT	FINISH	FINISH AND SPECIFICATION
03	BODY	GOLD	0.000010"MIN. GOLD PER ASTM B488, TYPE II, CODE C OVER 0.000100"MIN. NICKEL PER SAE-AMS-QQ-N-290, CLASS 2
	SPRING (CAGE)	GOLD	0.000030"MIN. GOLD PER ASTM B488, TYPE II, CODE C OVER 0.000100"MIN. NICKEL PER SAE-AMS-QQ-N-290, CLASS 2
	MOUNTING BRACKET	N/A	N/A
035	BODY	GOLD	0.000020"MIN. GOLD PER ASTM B488, TYPE II, CODE C OVER 0.000100"MIN. NICKEL PER SAE-AMS-QQ-N-290, CLASS 2
	SPRING (CAGE)	GOLD	0.000050"MIN. GOLD PER ASTM B488, TYPE II, CODE C OVER 0.000100"MIN. NICKEL PER SAE-AMS-QQ-N-290, CLASS 2
	MOUNTING BRACKET	N/A	N/A
04	BODY	ELECTRO-TIN	0.000100"MIN. ELECTRO-TIN PER ASTM B545 OVER 0.000100"MIN. NICKEL PER SAE-AMS-QQ-N-290, CLASS 2
	SPRING (CAGE)	BRIGHT ELECTRO-TIN	0.000200"MIN. BRIGHT ELECTRO-TIN PER ASTM B545 OVER 0.000050"MIN. NICKEL PER SAE-AMS-QQ-N-290, CLASS 2
	MOUNTING BRACKET	N/A	N/A
06	BODY	ELECTRO-TIN	0.000100"MIN. ELECTRO-TIN PER ASTM B545 OVER 0.000100"MIN. NICKEL PER SAE-AMS-QQ-N-290, CLASS 2
	SPRING (CAGE)	GOLD	0.000030"MIN. GOLD PER ASTM B488, TYPE II, CODE C OVER 0.000100"MIN. NICKEL PER SAE-AMS-QQ-N-290, CLASS 2
	MOUNTING BRACKET	N/A	N/A
063	BODY	BRIGHT TIN-LEAD	0.000200"MIN. BRIGHT TIN-LEAD (Sn93%-Pb7%) PER ASTM B545 OVER 0.000100"MIN. NICKEL PER SAE-AMS-QQ-N-290, CLASS 2
	SPRING (CAGE)	GOLD	0.000030"MIN. GOLD PER ASTM B488, TYPE II, CODE C OVER 0.000100"MIN. NICKEL PER SAE-AMS-QQ-N-290, CLASS 2
	MOUNTING BRACKET	N/A	N/A
088	BODY	BRIGHT TIN-LEAD	0.000200"MIN. BRIGHT TIN-LEAD (Sn93%-Pb7%) PER ASTM B545 OVER 0.000100"MIN. NICKEL PER SAE-AMS-QQ-N-290, CLASS 2
	SPRING (CAGE)	BRIGHT TIN-LEAD	0.000200"MIN. BRIGHT TIN-LEAD (Sn93%-Pb7%) PER ASTM B545 OVER 0.000100"MIN. NICKEL PER SAE-AMS-QQ-N-290, CLASS 2
	MOUNTING BRACKET	N/A	N/A

INSULATION COLOR OPTIONS:

09-9012-1-XXXX

INSULATION COLOR	BLACK	BLUE	BROWN	GRAY	GREEN	ORANGE	RED	VIOLET	WHITE	YELLOW
COLOR CODE NO.	10	16	11	18	15	13	12	17	19	14

TOLERANCES:*

DECIMAL	FRACTIONAL	ANGULAR	DRAWING ORIGATION DATE	LAST MODIFICATION DATE
± 0.010	± 1/64	± 5 °	8/31/2000	1/1/2017

*All dimensions are in inches.

RoHS COMPLIANCE:

09-9012-1-03XX

PART NUMBER	RoHS COMPLIANT
09-9012-1-0310	YES
09-9012-1-0311	NO
09-9012-1-0312	NO
09-9012-1-0313	NO
09-9012-1-0314	NO
09-9012-1-0315	YES
09-9012-1-0316	YES
09-9012-1-0317	YES
09-9012-1-0318	NO
09-9012-1-0319	YES

09-9012-1-035XX

PART NUMBER	RoHS COMPLIANT
09-9012-1-03510	YES
09-9012-1-03511	NO
09-9012-1-03512	NO
09-9012-1-03513	NO
09-9012-1-03514	NO
09-9012-1-03515	YES
09-9012-1-03516	YES
09-9012-1-03517	YES
09-9012-1-03518	NO
09-9012-1-03519	YES

09-9012-1-04XX

PART NUMBER	RoHS COMPLIANT
09-9012-1-0410	YES
09-9012-1-0411	NO
09-9012-1-0412	NO
09-9012-1-0413	NO
09-9012-1-0414	NO
09-9012-1-0415	YES
09-9012-1-0416	YES
09-9012-1-0417	YES
09-9012-1-0418	NO
09-9012-1-0419	YES

09-9012-1-06XX

PART NUMBER	RoHS COMPLIANT
09-9012-1-0610	YES
09-9012-1-0611	NO
09-9012-1-0612	NO
09-9012-1-0613	NO
09-9012-1-0614	NO
09-9012-1-0615	YES
09-9012-1-0616	YES
09-9012-1-0617	YES
09-9012-1-0618	NO
09-9012-1-0619	YES

09-9012-1-063XX

PART NUMBER	RoHS COMPLIANT
09-9012-1-06310	NO
09-9012-1-06311	NO
09-9012-1-06312	NO
09-9012-1-06313	NO
09-9012-1-06314	NO
09-9012-1-06315	NO
09-9012-1-06316	NO
09-9012-1-06317	NO
09-9012-1-06318	NO
09-9012-1-06319	NO

09-9012-1-088XX

PART NUMBER	RoHS COMPLIANT
09-9012-1-08810	NO
09-9012-1-08811	NO
09-9012-1-08812	NO
09-9012-1-08813	NO
09-9012-1-08814	NO
09-9012-1-08815	NO
09-9012-1-08816	NO
09-9012-1-08817	NO
09-9012-1-08818	NO
09-9012-1-08819	NO

MILITARY REFERENCE SPECIFICATIONS:

09-9012-1-03XX

PART NUMBER	MIL SPECIFICATION	MIL PART NUMBER
09-9012-1-0310	N/A	N/A
09-9012-1-0311	N/A	N/A
09-9012-1-0312	N/A	N/A
09-9012-1-0313	N/A	N/A
09-9012-1-0314	N/A	N/A
09-9012-1-0315	N/A	N/A
09-9012-1-0316	N/A	N/A

09-9012-1-035XX

PART NUMBER	MIL SPECIFICATION	MIL PART NUMBER
09-9012-1-03510	N/A	N/A
09-9012-1-03511	N/A	N/A
09-9012-1-03512	N/A	N/A
09-9012-1-03513	N/A	N/A
09-9012-1-03514	N/A	N/A
09-9012-1-03515	N/A	N/A
09-9012-1-03516	N/A	N/A

Continued on next page...

MILITARY REFERENCE SPECIFICATIONS CONTINUED:

09-9012-1-03XX

PART NUMBER	MIL SPECIFICATION	MIL PART NUMBER
09-9012-1-0317	N/A	N/A
09-9012-1-0318	N/A	N/A
09-9012-1-0319	N/A	N/A

09-9012-1-035XX

PART NUMBER	MIL SPECIFICATION	MIL PART NUMBER
09-9012-1-03517	N/A	N/A
09-9012-1-03518	N/A	N/A
09-9012-1-03519	N/A	N/A

09-9012-1-04XX

PART NUMBER	MIL SPECIFICATION	MIL PART NUMBER
09-9012-1-0410	N/A	N/A
09-9012-1-0411	N/A	N/A
09-9012-1-0412	N/A	N/A
09-9012-1-0413	N/A	N/A
09-9012-1-0414	N/A	N/A
09-9012-1-0415	N/A	N/A
09-9012-1-0416	N/A	N/A
09-9012-1-0417	N/A	N/A
09-9012-1-0418	N/A	N/A
09-9012-1-0419	N/A	N/A

09-9012-1-06XX

PART NUMBER	MIL SPECIFICATION	MIL PART NUMBER
09-9012-1-0610	N/A	N/A
09-9012-1-0611	N/A	N/A
09-9012-1-0612	N/A	N/A
09-9012-1-0613	N/A	N/A
09-9012-1-0614	N/A	N/A
09-9012-1-0615	N/A	N/A
09-9012-1-0616	N/A	N/A
09-9012-1-0617	N/A	N/A
09-9012-1-0618	N/A	N/A
09-9012-1-0619	N/A	N/A

09-9012-1-063XX

PART NUMBER	MIL SPECIFICATION	MIL PART NUMBER
09-9012-1-06310	N/A	N/A
09-9012-1-06311	N/A	N/A
09-9012-1-06312	N/A	N/A
09-9012-1-06313	N/A	N/A
09-9012-1-06314	N/A	N/A
09-9012-1-06315	N/A	N/A
09-9012-1-06316	N/A	N/A
09-9012-1-06317	N/A	N/A
09-9012-1-06318	N/A	N/A
09-9012-1-06319	N/A	N/A

09-9012-1-088XX

PART NUMBER	MIL SPECIFICATION	MIL PART NUMBER
09-9012-1-08810	N/A	N/A
09-9012-1-08811	N/A	N/A
09-9012-1-08812	N/A	N/A
09-9012-1-08813	N/A	N/A
09-9012-1-08814	N/A	N/A
09-9012-1-08815	N/A	N/A
09-9012-1-08816	N/A	N/A
09-9012-1-08817	N/A	N/A
09-9012-1-08818	N/A	N/A
09-9012-1-08819	N/A	N/A

TOOLING:

INSTALLATION TOOL: ARBOR PRESS	INSTALLATION TOOL: ANVIL (ARBOR PRESS OPERATED)	INSTALLATION TOOL: PRESS-FIT / ROLL SWAGE / RIVET PUNCH (ARBOR PRESS OPERATED)	INSTALLATION TOOL: PRESS-FIT (HAND OPERATED)	CRIMPING TOOL (COMMERCIAL VERSION)
TM1	TA09-9012	TPP09-9012	TTJ09-9012	N/A

NOTES:

DATASHEET NOTES

CLOSED ENTRY CAGE.

INSTRUCTION NOTES

SEE GENERAL PRESS FIT INSTALLATION INSTRUCTION ON CONCORD ELECTRONICS' WEBSITE WWW.CONCORD-ELECTRONICS.COM
