

DRAWING NUMBER:	01-1061-1-XXXX
PRODUCT GROUP:	BINDING POSTS
SUB-GROUP:	COMMERCIAL GROUNDING BINDING POSTS
DESCRIPTION:	GROUNDING BINDING POST - MOLDED HEAD

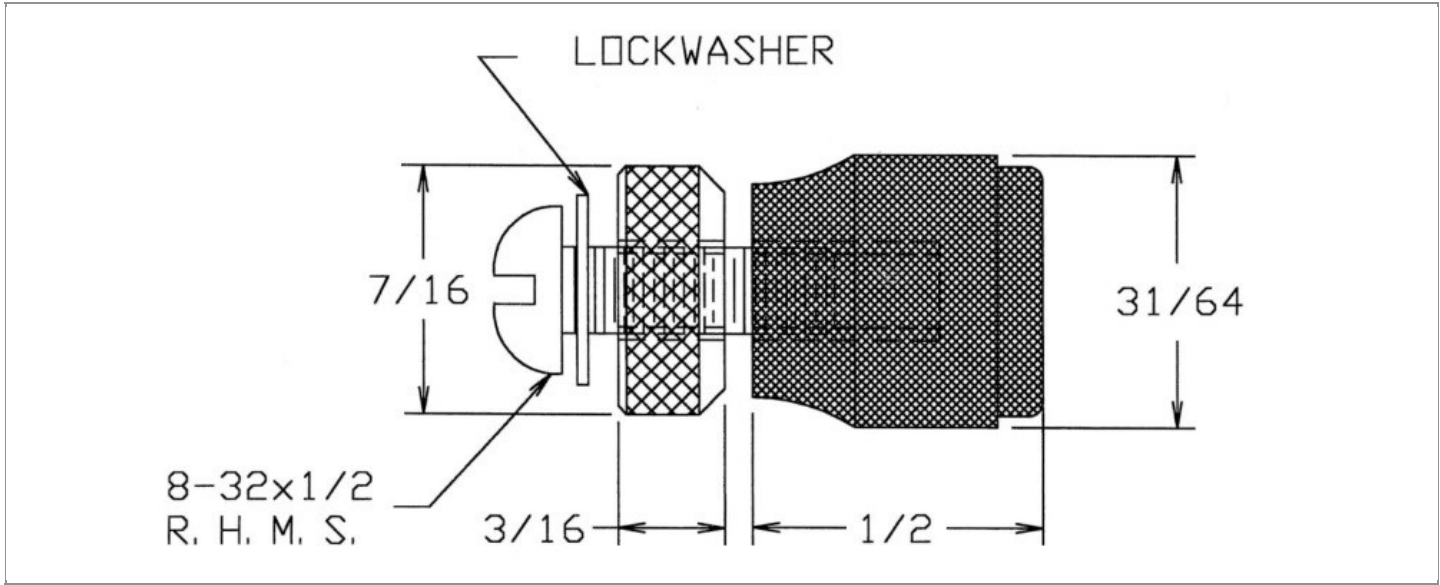

OVERALL LENGTH	BOARD / PANEL MOUNTING METHOD	MOUNTING HOLE SIZE	DRILL SIZE	BOARD / PANEL THICKNESS
0.850" MAX.	THREAD MOUNT (8-32 SCREW)	CLEARANCE FOR SCREW #8	#18	1/16" - 3/16"

PART NO. STRUCTURE:

01-1061	-	1	-	XX	XX
PART SERIES		DIMENSION		FINISH	INSULATION COLOR

MATERIAL OPTIONS:

01-1061-1-XXXX

COMPONENT	MATERIAL	MATERIAL AND SPECIFICATION
BODY	BRASS	BRASS
HEAD	MOLDED THERMOPLASTIC	MOLDED THERMOPLASTIC
NUT	BRASS	BRASS
WASHER	STEEL	STEEL
SCREW	BRASS	BRASS

FINISH - PLATING OPTIONS:

01-1061-1-XXXX

FINISH CODE	COMPONENT	FINISH	FINISH AND SPECIFICATION
02	BODY	NICKEL	NICKEL
	HEAD	N/A	N/A
	NUT	NICKEL	NICKEL
	WASHER	ZINC	ZINC CLEAR
	SCREW	NICKEL	NICKEL

INSULATION COLOR OPTIONS:

01-1061-1-XXXX

INSULATION COLOR	BLACK	RED
COLOR CODE NO.	10	12

TOLERANCES:*

DECIMAL	FRACTIONAL	ANGULAR	DRAWING ORIGINATION DATE	LAST MODIFICATION DATE
± 0.010	± 1/64	± 5°	5/19/1998	5/1/2017

*All dimensions are in inches.

RoHS COMPLIANCE:

01-1061-1-02XX

PART NUMBER	RoHS COMPLIANT
01-1061-1-0210	YES
01-1061-1-0212	YES

NOTES:

DATASHEET NOTES

RATED: 15 AMPERES CONTINUOUS DUTY. ATTACHED TO BOARD WITH SCREW, LOCKWASHER AND KNURLED NUT. KNURLED MOLDED PLASTIC CLAMPING KNOB USES TO TIGHTEN LEAD/WIRE/SPADE LUG.

INSTRUCTION NOTES

SUPPLIED WITH: NICKEL PLATED KNURLED BRASS NUT (8-32 x 7/16" x 3/16"), ZINC PLATED STEEL #8 LOCKWASHER, P/N 701-7708, NICKEL PLATED ROUND HEAD SLOTTED BRASS #8 SCREW, P/N 701-7237-02 (8-32 x 1/2").