

DRAWING NUMBER:	01-2312-X-XX
PRODUCT GROUP:	BANANA PLUGS, JACKS AND PHONE TIPS
SUB-GROUP:	NON-INSULATED BANANA PLUGS
DESCRIPTION:	NON-INSULATED STANDARD BANANA PLUG

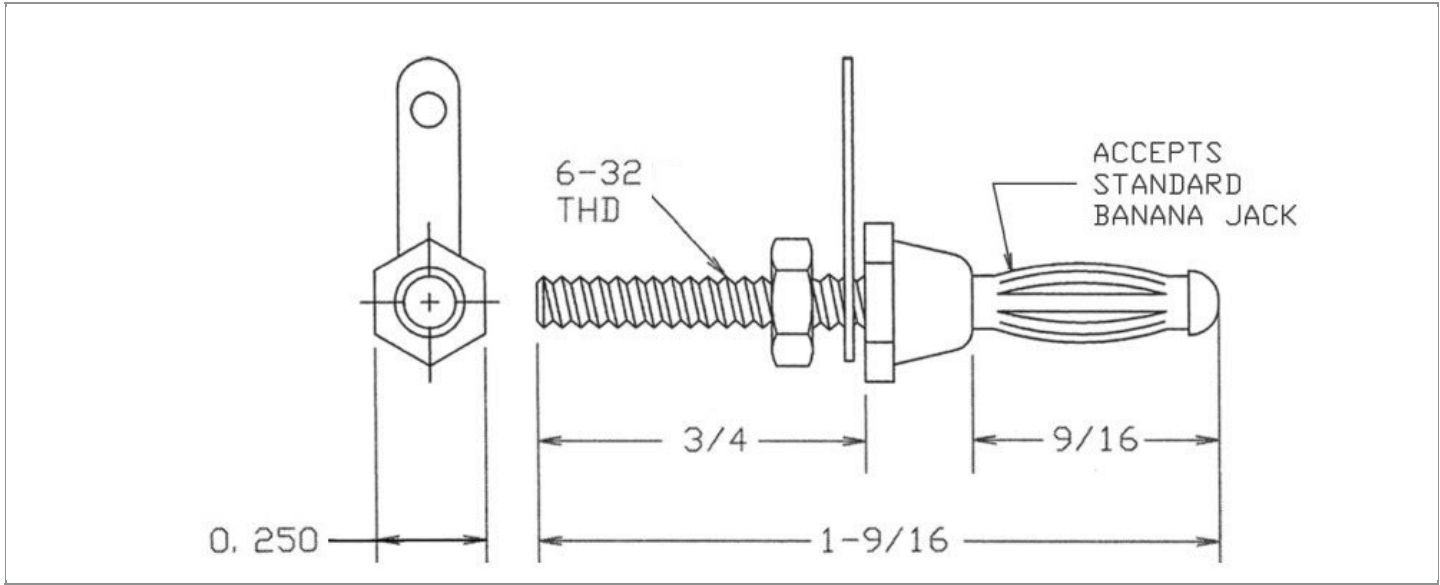

ACCEPTS PIN / PLUG / JACK SIZE	BOARD / PANEL MOUNTING METHOD	MOUNTING HOLE SIZE	DRILL SIZE
STANDARD BANANA JACK	THREAD MOUNT (6-32 NUT)	0.154" ± 0.002	#23

PART NO. STRUCTURE:

01-2312 - 1 - XX
 PART SERIES DIMENSION FINISH

MATERIAL OPTIONS:

01-2312-1-XX

COMPONENT	MATERIAL	MATERIAL AND SPECIFICATION
BODY	BRASS	BRASS PER ASTM B16, ALLOY C36000, 1/2 HARD
SPRING (CAGE)	BERYLLIUM COPPER	BERYLLIUM COPPER PER ASTM B194, ALLOY C17200
NUT	BRASS	BRASS PER ASTM B16, ALLOY C36000, 1/2 HARD
SCREW	N/A	N/A
STUD	N/A	N/A
LUG	BRASS	BRASS PER ASTM B36, ALLOY C26000, 1/2 HARD

DIMENSION OPTIONS:

01-2312-1-XX

DIMENSION	SHANK LENGTH (L)	BOARD/PANEL THICKNESS
1	0.750"	UP TO 5/8"

FINISH - PLATING OPTIONS:

01-2312-1-XX

FINISH CODE	COMPONENT	FINISH	FINISH AND SPECIFICATION
01	BODY	SILVER	0.000100"MIN. SILVER PER ASTM B700, TYPE 2, GRADE D WITH A NON-CHROMATE PRESERVATIVE TREATMENT
	SPRING (CAGE)	SILVER	0.000300"MIN. SILVER PER ASTM B700, TYPE 2, GRADE D WITH A NON-CHROMATE PRESERVATIVE TREATMENT
	NUT	NICKEL	0.000100"MIN. NICKEL PER SAE-AMS-QQ-N-290
	SCREW	N/A	N/A
	STUD	N/A	N/A
	LUG	ELECTRO-TIN	0.000150"MIN. ELECTRO-TIN PER ASTM B545
02	BODY	NICKEL	0.000100"MIN. NICKEL PER SAE-AMS-QQ-N-290
	SPRING (CAGE)	NICKEL	0.000200"MIN. NICKEL PER SAE-AMS-QQ-N-290
	NUT	NICKEL	0.000100"MIN. NICKEL PER SAE-AMS-QQ-N-290
	SCREW	N/A	N/A
	STUD	N/A	N/A
	LUG	ELECTRO-TIN	0.000150"MIN. ELECTRO-TIN PER ASTM B545
03	BODY	GOLD	GOLD FLASH PER ASTM B488, TYPE II, CODE C
	SPRING (CAGE)	GOLD	0.000010"MIN. GOLD PER ASTM B488, TYPE II, CODE C
	NUT	NICKEL	0.000100"MIN. NICKEL PER SAE-AMS-QQ-N-290
	SCREW	N/A	N/A
	STUD	N/A	N/A
	LUG	ELECTRO-TIN	0.000150"MIN. ELECTRO-TIN PER ASTM B545

Continued on next page...

FINISH - PLATING OPTIONS CONTINUED:

01-2312-1-XX

FINISH CODE	COMPONENT	FINISH	FINISH AND SPECIFICATION
044	BODY	BRIGHT ELECTRO-TIN	0.000200"MIN. BRIGHT ELECTRO-TIN PER ASTM B545
	SPRING (CAGE)	BRIGHT ELECTRO-TIN	0.000200"MIN. BRIGHT ELECTRO-TIN PER ASTM B545
	NUT	NICKEL	0.000100"MIN. NICKEL PER SAE-AMS-QQ-N-290
	SCREW	N/A	N/A
	STUD	N/A	N/A
	LUG	ELECTRO-TIN	0.000150"MIN. ELECTRO-TIN PER ASTM B545

TOLERANCES:*

DECIMAL	FRACTIONAL	ANGULAR	DRAWING ORIGATION DATE	LAST MODIFICATION DATE
± 0.010	± 1/64	± 5°	2/17/1999	4/1/2017

*All dimensions are in inches.

RoHS COMPLIANCE:

01-2312-1-XX

PART NUMBER	RoHS COMPLIANT
01-2312-1-01	YES
01-2312-1-02	YES
01-2312-1-03	YES
01-2312-1-044	YES

TOOLING:

INSTALLATION TOOL: ARBOR PRESS	INSTALLATION TOOL: ANVIL (ARBOR PRESS OPERATED)	INSTALLATION TOOL: PRESS-FIT / ROLL SWAGE / RIVET PUNCH (ARBOR PRESS OPERATED)
N/A	N/A	N/A

NOTES:

DATASHEET NOTES

RATED: 15 AMPERES CONTINUOUS DUTY. STANDARD SIZE SPRING FOR STANDARD SIZE BANANA JACK. NUT PART NUMBER: 701-7319-02, LUG PART NUMBER: 707-0026.

INSTRUCTION NOTES

SUPPLIED WITH NICKEL PLATED BRASS HEX NUT (6-32 x 1/4" x 3/32") AND ELECTRO-TIN PLATED BRASS LUG.