

DRAWING NUMBER:	09-8085-1-XX
PRODUCT GROUP:	TERMINALS
SUB-GROUP:	COMMERCIAL NON-INSULATED WIRE APPLIED PIN TERMINALS
DESCRIPTION:	NON-INSULATED PIN TERMINAL, CRIMP BARREL MS3190 TYPE

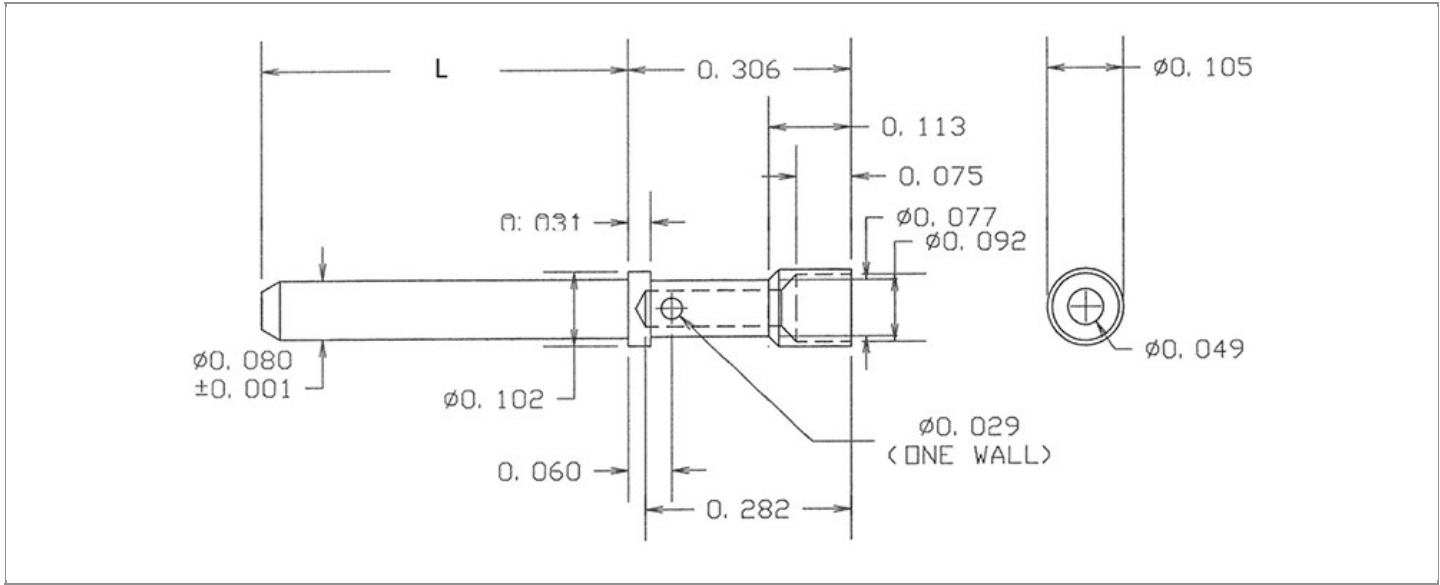

CABLE / WIRE SIZE	PIN DIAMETER	OVERALL LENGTH	MIN. HOLE DEPTH
22 AWG	0.080" ± 0.001	0.506"	0.169"

PART NO. STRUCTURE:

09-8085	-	1	-	XX
PART SERIES		DIMENSION		FINISH

MATERIAL OPTIONS:

09-8085-1-XX

COMPONENT	MATERIAL	MATERIAL AND SPECIFICATION
PIN	BRASS	BRASS PER ASTM B16, ALLOY C36000, 1/2 HARD

FINISH - PLATING OPTIONS:

09-8085-1-XX

FINISH CODE	COMPONENT	FINISH	FINISH AND SPECIFICATION
03	PIN	GOLD	0.000010"MIN. GOLD PER ASTM B488, TYPE II, CODE C OVER 0.000050"MIN. NICKEL PER SAE-AMS-QQ-N-290
035	PIN	GOLD	0.000050"MIN. GOLD PER ASTM B488, TYPE II, CODE C OVER 0.000050"MIN. NICKEL PER SAE-AMS-QQ-N-290
04	PIN	ELECTRO-TIN	0.000300"MIN. ELECTRO-TIN PER ASTM B545 OVER 0.000100"MIN. COPPER PER SAE-AMS-2418
044	PIN	BRIGHT ELECTRO-TIN	0.000300"MIN. BRIGHT ELECTRO-TIN PER ASTM B545 OVER 0.000100"MIN. COPPER PER SAE-AMS-2418

Continued on next page...

FINISH - PLATING OPTIONS CONTINUED:

09-8085-1-XX

FINISH CODE	COMPONENT	FINISH	FINISH AND SPECIFICATION
05	PIN	ELECTRO-SOLDER	0.000300"MIN. ELECTRO-SOLDER PER SAE-AMS-P-81728 OVER 0.000100"MIN. COPPER PER SAE-AMS-2418
088	PIN	BRIGHT TIN-LEAD	0.000300"MIN. BRIGHT TIN-LEAD (Sn93%-Pb7%) PER ASTM B545 OVER 0.000100"MIN. COPPER PER SAE-AMS-2418

TOLERANCES:*

DECIMAL	FRACTIONAL	ANGULAR	DRAWING ORIGATION DATE	LAST MODIFICATION DATE
± 0.005	± 1/64	± 5°	7/8/1997	3/1/2017

*All dimensions are in inches.

RoHS COMPLIANCE:

09-8085-1-XX

PART NUMBER	RoHS COMPLIANT
09-8085-1-03	YES
09-8085-1-035	YES
09-8085-1-04	YES
09-8085-1-044	YES
09-8085-1-05	NO
09-8085-1-088	NO

TOOLING:

**CRIMPING TOOL
(COMMERCIAL VERSION)**

701-2860 (CRIMPING DIE RANGE: 10-22)

NOTES:

DATASHEET NOTES

RECOMMENDED WIRE FOR CRIMPING: 22 AWG, 7 STRAND, NO. 30 COPPER WIRE, PTFE INSULATED, 0.054" MAX. DIA OVER INSULATION. MINIMUM CRIMPING HOLE DEPTH: 0.169".

INSTRUCTION NOTES

STRIP INSULATION OF 22 AWG WIRE TO LENGTH OF MIN. CRIMPING HOLE DEPTH OF BARREL AND INSERT IT INTO END HOLE OF PIN. CRIMP BARREL AND SOLDER THRU SIDE HOLE. WIPE OFF EXCESS SOLDER.