

<b>DRAWING NUMBER:</b>	<b>09-9659-X-XX</b>
<b>PRODUCT GROUP:</b>	PC JACKS
<b>SUB-GROUP:</b>	NON-INSULATED PC JACKS
<b>DESCRIPTION:</b>	PC JACK - NON-INSULATED

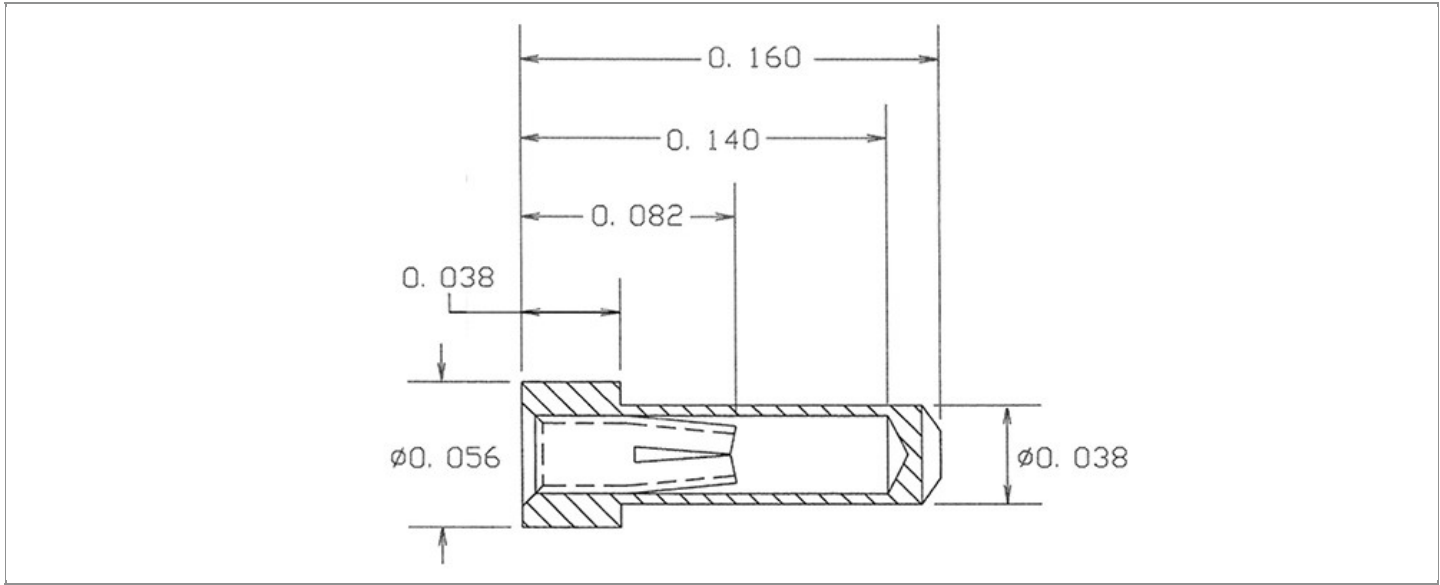

ACCEPTS PIN / PLUG / JACK SIZE	MOUNTING ORIENTATION	BOARD / PANEL MOUNTING METHOD	MOUNTING HOLE SIZE	DRILL SIZE	FEED THRU COMBINATION
0.015" - 0.021"	VERTICAL	SOLDER	0.042" ± 0.002	#58	N/A

**PART NO. STRUCTURE:**

<b>09-9659</b>	-	<b>1</b>	-	<b>XX</b>
PART SERIES		DIMENSION		FINISH

**MATERIAL OPTIONS:**

**09-9659-1-XX**

COMPONENT	MATERIAL	MATERIAL AND SPECIFICATION
<b>BODY</b>	BRASS	BRASS PER ASTM B16, ALLOY C36000, 1/2 HARD
<b>SPRING (CAGE)</b>	BERYLLIUM COPPER	BERYLLIUM COPPER PER ASTM B194, ALLOY C17200
<b>MOUNTING BRACKET</b>	N/A	N/A

DIMENSION OPTIONS:

09-9659-1-XX

DIMENSION	A	H	OVERALL LENGTH	MIN. HOLE DEPTH	SHANK LENGTH (L)	BOARD/PANEL THICKNESS
1	N/A	N/A	0.160"	0.140"	N/A	1/32" - 3/32"

FINISH - PLATING OPTIONS:

09-9659-1-XX

FINISH CODE	COMPONENT	FINISH	FINISH AND SPECIFICATION
03	BODY	GOLD	0.000010"MIN. GOLD PER ASTM B488, TYPE II, CODE C OVER 0.000100"MIN. NICKEL PER SAE-AMS-QQ-N-290, CLASS 2
	SPRING (CAGE)	GOLD	0.000030"MIN. GOLD PER ASTM B488, TYPE II, CODE C OVER 0.000100"MIN. NICKEL PER SAE-AMS-QQ-N-290, CLASS 2
	MOUNTING BRACKET	N/A	N/A
035	BODY	GOLD	0.000020"MIN. GOLD PER ASTM B488, TYPE II, CODE C OVER 0.000100"MIN. NICKEL PER SAE-AMS-QQ-N-290, CLASS 2
	SPRING (CAGE)	GOLD	0.000050"MIN. GOLD PER ASTM B488, TYPE II, CODE C OVER 0.000100"MIN. NICKEL PER SAE-AMS-QQ-N-290, CLASS 2
	MOUNTING BRACKET	N/A	N/A
04	BODY	ELECTRO-TIN	0.000100"MIN. ELECTRO-TIN PER ASTM B545 OVER 0.000100"MIN. NICKEL PER SAE-AMS-QQ-N-290, CLASS 2
	SPRING (CAGE)	BRIGHT ELECTRO-TIN	0.000200"MIN. BRIGHT ELECTRO-TIN PER ASTM B545 OVER 0.000050"MIN. NICKEL PER SAE-AMS-QQ-N-290, CLASS 2
	MOUNTING BRACKET	N/A	N/A
06	BODY	ELECTRO-TIN	0.000100"MIN. ELECTRO-TIN PER ASTM B545 OVER 0.000100"MIN. NICKEL PER SAE-AMS-QQ-N-290, CLASS 2
	SPRING (CAGE)	GOLD	0.000030"MIN. GOLD PER ASTM B488, TYPE II, CODE C OVER 0.000100"MIN. NICKEL PER SAE-AMS-QQ-N-290, CLASS 2
	MOUNTING BRACKET	N/A	N/A
063	BODY	BRIGHT TIN-LEAD	0.000200"MIN. BRIGHT TIN-LEAD (Sn93%-Pb7%) PER ASTM B545 OVER 0.000100"MIN. NICKEL PER SAE-AMS-QQ-N-290, CLASS 2
	SPRING (CAGE)	GOLD	0.000030"MIN. GOLD PER ASTM B488, TYPE II, CODE C OVER 0.000100"MIN. NICKEL PER SAE-AMS-QQ-N-290, CLASS 2
	MOUNTING BRACKET	N/A	N/A
088	BODY	BRIGHT TIN-LEAD	0.000200"MIN. BRIGHT TIN-LEAD (Sn93%-Pb7%) PER ASTM B545 OVER 0.000100"MIN. NICKEL PER SAE-AMS-QQ-N-290, CLASS 2
	SPRING (CAGE)	BRIGHT TIN-LEAD	0.000200"MIN. BRIGHT TIN-LEAD (Sn93%-Pb7%) PER ASTM B545 OVER 0.000100"MIN. NICKEL PER SAE-AMS-QQ-N-290, CLASS 2
	MOUNTING BRACKET	N/A	N/A

TOLERANCES:\*

DECIMAL	FRACTIONAL	ANGULAR	DRAWING ORIGATION DATE	LAST MODIFICATION DATE
± 0.002 DIA. ( ± 0.005 LENGTH)	± 1/64	± 5 °	05/09/00	01/01/17

\*All dimensions are in inches.

RoHS COMPLIANCE:

09-9659-1-XX

PART NUMBER	RoHS COMPLIANT
09-9659-1-03	YES
09-9659-1-035	YES
09-9659-1-04	YES
09-9659-1-06	YES
09-9659-1-063	NO
09-9659-1-088	NO

TOOLING:

INSTALLATION TOOL: ARBOR PRESS	INSTALLATION TOOL: ANVIL (ARBOR PRESS OPERATED)	INSTALLATION TOOL: PRESS-FIT / ROLL SWAGE / RIVET PUNCH (ARBOR PRESS OPERATED)	CRIMPING TOOL (COMMERCIAL VERSION)
N/A	N/A	N/A	N/A

NOTES:

DATASHEET NOTES
THE MINIMUM PIN DIAMETER SHOULD BE NO MORE THAN 0.004" SMALLER THAN THE MAXIMUM PIN DIAMETER INSERTED.
INSTRUCTION NOTES
N/A