

DRAWING NUMBER:	09-9038-X-XX
PRODUCT GROUP:	PC JACKS
SUB-GROUP:	NON-INSULATED PC JACKS
DESCRIPTION:	PC JACK - NON-INSULATED

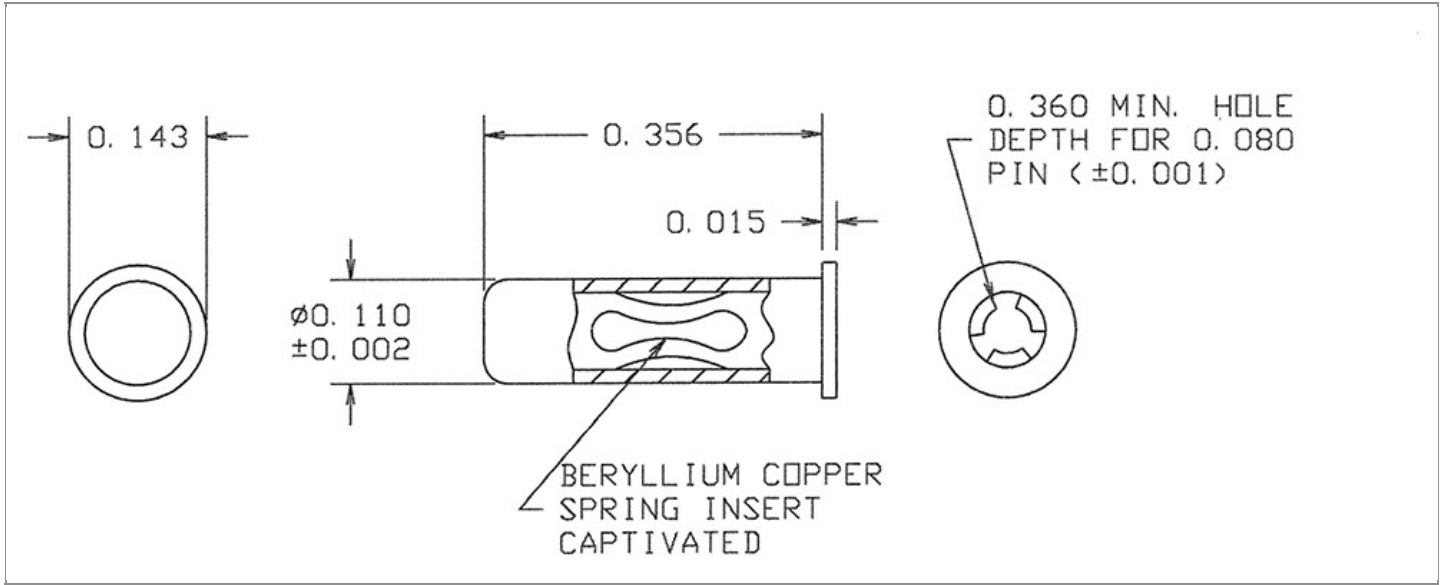

ACCEPTS PIN / PLUG / JACK SIZE	MOUNTING ORIENTATION	BOARD / PANEL MOUNTING METHOD	MOUNTING HOLE SIZE	DRILL SIZE	FEED THRU COMBINATION
0.080" ± 0.001	VERTICAL	SOLDER	0.116" ± 0.002	#32	N/A

PART NO. STRUCTURE:

09-9038 - 1 - XX
 PART SERIES DIMENSION FINISH

MATERIAL OPTIONS:

09-9038-1-XX

COMPONENT	MATERIAL	MATERIAL AND SPECIFICATION
BODY	BRASS	BRASS PER ASTM B16, ALLOY C36000, 1/2 HARD
SPRING (CAGE)	BERYLLIUM COPPER	BERYLLIUM COPPER PER ASTM B194, ALLOY C17200
MOUNTING BRACKET	N/A	N/A

DIMENSION OPTIONS:

09-9038-1-XX

DIMENSION	A	H	OVERALL LENGTH	MIN. HOLE DEPTH	SHANK LENGTH (L)	BOARD/PANEL THICKNESS
1	N/A	N/A	0.371"	0.360"	N/A	1/32" - 5/16"

FINISH - PLATING OPTIONS:

09-9038-1-XX

FINISH CODE	COMPONENT	FINISH	FINISH AND SPECIFICATION
03	BODY	GOLD	0.000010"MIN. GOLD PER ASTM B488, TYPE II, CODE C OVER 0.000100"MIN. NICKEL PER SAE-AMS-QQ-N-290, CLASS 2
	SPRING (CAGE)	GOLD	0.000030"MIN. GOLD PER ASTM B488, TYPE II, CODE C OVER 0.000100"MIN. NICKEL PER SAE-AMS-QQ-N-290, CLASS 2
	MOUNTING BRACKET	N/A	N/A
035	BODY	GOLD	0.000020"MIN. GOLD PER ASTM B488, TYPE II, CODE C OVER 0.000100"MIN. NICKEL PER SAE-AMS-QQ-N-290, CLASS 2
	SPRING (CAGE)	GOLD	0.000050"MIN. GOLD PER ASTM B488, TYPE II, CODE C OVER 0.000100"MIN. NICKEL PER SAE-AMS-QQ-N-290, CLASS 2
	MOUNTING BRACKET	N/A	N/A
04	BODY	ELECTRO-TIN	0.000100"MIN. ELECTRO-TIN PER ASTM B545 OVER 0.000100"MIN. NICKEL PER SAE-AMS-QQ-N-290, CLASS 2
	SPRING (CAGE)	BRIGHT ELECTRO-TIN	0.000200"MIN. BRIGHT ELECTRO-TIN PER ASTM B545 OVER 0.000050"MIN. NICKEL PER SAE-AMS-QQ-N-290, CLASS 2
	MOUNTING BRACKET	N/A	N/A
06	BODY	ELECTRO-TIN	0.000100"MIN. ELECTRO-TIN PER ASTM B545 OVER 0.000100"MIN. NICKEL PER SAE-AMS-QQ-N-290, CLASS 2
	SPRING (CAGE)	GOLD	0.000030"MIN. GOLD PER ASTM B488, TYPE II, CODE C OVER 0.000100"MIN. NICKEL PER SAE-AMS-QQ-N-290, CLASS 2
	MOUNTING BRACKET	N/A	N/A
063	BODY	BRIGHT TIN-LEAD	0.000200"MIN. BRIGHT TIN-LEAD (Sn93%-Pb7%) PER ASTM B545 OVER 0.000100"MIN. NICKEL PER SAE-AMS-QQ-N-290, CLASS 2
	SPRING (CAGE)	GOLD	0.000030"MIN. GOLD PER ASTM B488, TYPE II, CODE C OVER 0.000100"MIN. NICKEL PER SAE-AMS-QQ-N-290, CLASS 2
	MOUNTING BRACKET	N/A	N/A
088	BODY	BRIGHT TIN-LEAD	0.000200"MIN. BRIGHT TIN-LEAD (Sn93%-Pb7%) PER ASTM B545 OVER 0.000100"MIN. NICKEL PER SAE-AMS-QQ-N-290, CLASS 2
	SPRING (CAGE)	BRIGHT TIN-LEAD	0.000200"MIN. BRIGHT TIN-LEAD (Sn93%-Pb7%) PER ASTM B545 OVER 0.000100"MIN. NICKEL PER SAE-AMS-QQ-N-290, CLASS 2
	MOUNTING BRACKET	N/A	N/A

TOLERANCES:*

DECIMAL	FRACTIONAL	ANGULAR	DRAWING ORIGATION DATE	LAST MODIFICATION DATE
± 0.010	± 1/64	N/A	02/05/94	01/01/17

*All dimensions are in inches.

RoHS COMPLIANCE:

09-9038-1-XX

PART NUMBER	RoHS COMPLIANT
09-9038-1-03	YES
09-9038-1-035	YES
09-9038-1-04	YES
09-9038-1-06	YES
09-9038-1-063	NO
09-9038-1-088	NO

TOOLING:

INSTALLATION TOOL: ARBOR PRESS	INSTALLATION TOOL: ANVIL (ARBOR PRESS OPERATED)	INSTALLATION TOOL: PRESS-FIT / ROLL SWAGE / RIVET PUNCH (ARBOR PRESS OPERATED)	CRIMPING TOOL (COMMERCIAL VERSION)
N/A	N/A	N/A	N/A

NOTES:

DATASHEET NOTES
N/A
INSTRUCTION NOTES
N/A