

DRAWING NUMBER:	1100-07M-XXXXZ
PRODUCT GROUP:	TERMINALS
SUB-GROUP:	MILITARY INSULATED TERMINALS
DESCRIPTION:	PTFE INSULATED PIN TERMINAL

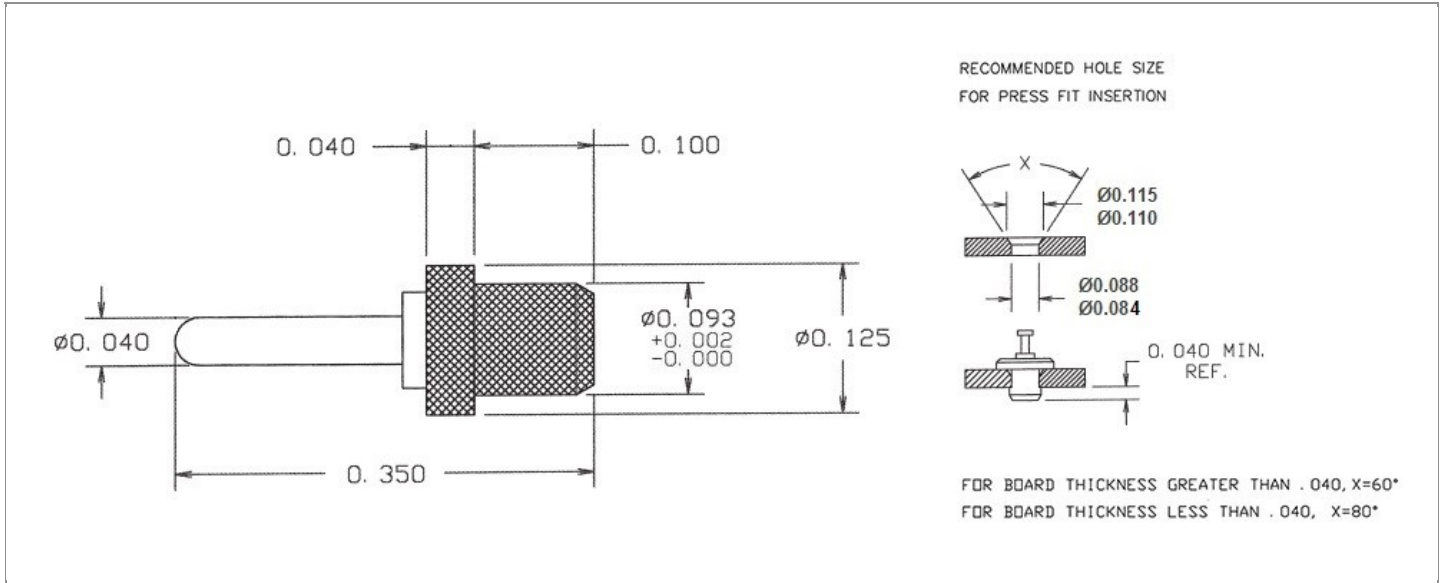

PIN DIAMETER	OVERALL LENGTH	MOUNTING ORIENTATION	BOARD / PANEL MOUNTING METHOD
0.040" ± 0.005	0.350"	VERTICAL	PRESS FIT

BOARD / PANEL THICKNESS	MOUNTING HOLE SIZE	DRILL SIZE	FEED THRU COMBINATION
UP TO 1/16"	0.086" ± 0.002	#44	N/A

PART NO. STRUCTURE:*

1100	-	07M	-	XX	XX
PART SERIES		DIMENSION		FINISH	INSULATION COLOR

*If applicable, "Z" at the end of a PART NO. STRUCTURE indicates TERMINAL MATERIAL TYPE.

MATERIAL OPTIONS:

1100-07M-XXXXZ

COMPONENT	MATERIAL	MATERIAL AND SPECIFICATION
TERMINAL	PHOSPHOR BRONZE	PHOSPHOR BRONZE PER ASTM B139, ALLOY C54400
BASE/METAL SLEEVE	N/A	N/A
INSULATION*	PTFE	PTFE PER ASTM D1710
NUT	N/A	N/A
WASHER	N/A	N/A

*For Insulation color, please see INSULATION COLOR OPTIONS on Page 2

FINISH - PLATING OPTIONS:

1100-07M-XXXXZ

FINISH CODE	COMPONENT	FINISH	FINISH AND SPECIFICATION
05	TERMINAL	ELECTRO-SOLDER	0.000300"MIN. ELECTRO-SOLDER PER SAE-AMS-P-81728 OVER 0.000100"MIN. COPPER PER SAE-AMS-2418
	BASE/METAL SLEEVE	N/A	N/A
	NUT	N/A	N/A
	WASHER	N/A	N/A
088	TERMINAL	BRIGHT TIN-LEAD	0.000300"MIN. BRIGHT TIN-LEAD (Sn93%-Pb7%) PER ASTM B545 OVER 0.000100"MIN. COPPER PER SAE-AMS-2418
	BASE/METAL SLEEVE	N/A	N/A
	NUT	N/A	N/A
	WASHER	N/A	N/A
095	TERMINAL	HOT SOLDER DIP	0.000100"MIN. HOT SOLDER DIP USING Sn60 PER IPC-J-STD-006 OVER 0.000100"MIN. COPPER PER SAE-AMS-2418
	BASE/METAL SLEEVE	N/A	N/A
	NUT	N/A	N/A
	WASHER	N/A	N/A

INSULATION COLOR OPTIONS:

1100-07M-XXXXZ

INSULATION COLOR	BLACK	BLUE	BROWN	GRAY	GREEN	ORANGE	RED	VIOLET	WHITE	YELLOW
COLOR CODE NO.	10	16	11	18	15	13	12	17	19	14

TOLERANCES:*

DECIMAL	FRACTIONAL	ANGULAR	DRAWING ORIENTATION DATE	LAST MODIFICATION DATE
± 0.015	N/A	± 3 °	1/8/1999	1/8/1999

*All dimensions are in inches.

RoHS COMPLIANCE:

1100-07M-05XXZ

PART NUMBER	RoHS COMPLIANT
1100-07M-0510Z	NO
1100-07M-0511Z	NO
1100-07M-0512Z	NO
1100-07M-0513Z	NO
1100-07M-0514Z	NO
1100-07M-0515Z	NO
1100-07M-0516Z	NO
1100-07M-0517Z	NO
1100-07M-0518Z	NO
1100-07M-0519Z	NO

1100-07M-088XXZ

PART NUMBER	RoHS COMPLIANT
1100-07M-08810Z	NO
1100-07M-08811Z	NO
1100-07M-08812Z	NO
1100-07M-08813Z	NO
1100-07M-08814Z	NO
1100-07M-08815Z	NO
1100-07M-08816Z	NO
1100-07M-08817Z	NO
1100-07M-08818Z	NO
1100-07M-08819Z	NO

1100-07M-095XXZ

PART NUMBER	RoHS COMPLIANT
1100-07M-09510Z	NO
1100-07M-09511Z	NO
1100-07M-09512Z	NO
1100-07M-09513Z	NO
1100-07M-09514Z	NO
1100-07M-09515Z	NO
1100-07M-09516Z	NO
1100-07M-09517Z	NO
1100-07M-09518Z	NO
1100-07M-09519Z	NO

MILITARY REFERENCE SPECIFICATIONS:

1100-07M-05XXZ

PART NUMBER	MIL SPECIFICATION	MIL PART NUMBER	COMMERCIAL ITEM DESCRIPTION (CID) SPECIFICATION	CID PART NUMBER
1100-07M-0510Z	MIL-T-55155/08	M55155/080B02 (SE080B02Z)	A-A-59126/08	AA59126/080B02
1100-07M-0511Z	MIL-T-55155/08	M55155/081B02 (SE081B02Z)	A-A-59126/08	AA59126/081B02
1100-07M-0512Z	MIL-T-55155/08	M55155/082B02 (SE082B02Z)	A-A-59126/08	AA59126/082B02
1100-07M-0513Z	MIL-T-55155/08	M55155/083B02 (SE083B02Z)	A-A-59126/08	AA59126/083B02
1100-07M-0514Z	MIL-T-55155/08	M55155/084B02 (SE084B02Z)	A-A-59126/08	AA59126/084B02
1100-07M-0515Z	MIL-T-55155/08	M55155/085B02 (SE085B02Z)	A-A-59126/08	AA59126/085B02
1100-07M-0516Z	MIL-T-55155/08	M55155/086B02 (SE086B02Z)	A-A-59126/08	AA59126/086B02
1100-07M-0517Z	MIL-T-55155/08	M55155/087B02 (SE087B02Z)	A-A-59126/08	AA59126/087B02
1100-07M-0518Z	MIL-T-55155/08	M55155/088B02 (SE088B02Z)	A-A-59126/08	AA59126/088B02
1100-07M-0519Z	MIL-T-55155/08	M55155/089B02 (SE089B02Z)	A-A-59126/08	AA59126/089B02

1100-07M-088XXZ

PART NUMBER	MIL SPECIFICATION	MIL PART NUMBER	COMMERCIAL ITEM DESCRIPTION (CID) SPECIFICATION	CID PART NUMBER
1100-07M-08810Z	MIL-T-55155/08	M55155/080D02	A-A-59126/08	AA59126/080D02
1100-07M-08811Z	MIL-T-55155/08	M55155/081D02	A-A-59126/08	AA59126/081D02
1100-07M-08812Z	MIL-T-55155/08	M55155/082D02	A-A-59126/08	AA59126/082D02
1100-07M-08813Z	MIL-T-55155/08	M55155/083D02	A-A-59126/08	AA59126/083D02
1100-07M-08814Z	MIL-T-55155/08	M55155/084D02	A-A-59126/08	AA59126/084D02

Continued on next page...

MILITARY REFERENCE SPECIFICATIONS CONTINUED:

1100-07M-088XXZ

PART NUMBER	MIL SPECIFICATION	MIL PART NUMBER	COMMERCIAL ITEM DESCRIPTION (CID) SPECIFICATION	CID PART NUMBER
1100-07M-08815Z	MIL-T-55155/08	M55155/085D02	A-A-59126/08	AA59126/085D02
1100-07M-08816Z	MIL-T-55155/08	M55155/086D02	A-A-59126/08	AA59126/086D02
1100-07M-08817Z	MIL-T-55155/08	M55155/087D02	A-A-59126/08	AA59126/087D02
1100-07M-08818Z	MIL-T-55155/08	M55155/088D02	A-A-59126/08	AA59126/088D02
1100-07M-08819Z	MIL-T-55155/08	M55155/089D02	A-A-59126/08	AA59126/089D02

1100-07M-095XXZ

PART NUMBER	MIL SPECIFICATION	MIL PART NUMBER	COMMERCIAL ITEM DESCRIPTION (CID) SPECIFICATION	CID PART NUMBER
1100-07M-09510Z	MIL-T-55155/08	M55155/080C02	A-A-59126/08	AA59126/080C02
1100-07M-09511Z	MIL-T-55155/08	M55155/081C02	A-A-59126/08	AA59126/081C02
1100-07M-09512Z	MIL-T-55155/08	M55155/082C02	A-A-59126/08	AA59126/082C02
1100-07M-09513Z	MIL-T-55155/08	M55155/083C02	A-A-59126/08	AA59126/083C02
1100-07M-09514Z	MIL-T-55155/08	M55155/084C02	A-A-59126/08	AA59126/084C02
1100-07M-09515Z	MIL-T-55155/08	M55155/085C02	A-A-59126/08	AA59126/085C02
1100-07M-09516Z	MIL-T-55155/08	M55155/086C02	A-A-59126/08	AA59126/086C02
1100-07M-09517Z	MIL-T-55155/08	M55155/087C02	A-A-59126/08	AA59126/087C02
1100-07M-09518Z	MIL-T-55155/08	M55155/088C02	A-A-59126/08	AA59126/088C02
1100-07M-09519Z	MIL-T-55155/08	M55155/089C02	A-A-59126/08	AA59126/089C02

TOOLING:

INSTALLATION TOOL: ARBOR PRESS	INSTALLATION TOOL: ANVIL (ARBOR PRESS OPERATED)	INSTALLATION TOOL: PRESS-FIT / ROLL SWAGE / RIVET PUNCH (ARBOR PRESS OPERATED)	INSTALLATION TOOL: PRESS-FIT (HAND OPERATED)
TM1	TA1100-07	TPI1100-07	TTI1100-07

NOTES:

DATASHEET NOTES

N/A

INSTRUCTION NOTES

SEE GENERAL PRESS FIT INSTALLATION INSTRUCTION ON CONCORD ELECTRONICS' WEBSITE WWW.CONCORD-ELECTRONICS.COM.