

DRAWING NUMBER:	01-4105-1-XX
PRODUCT GROUP:	BANANA PLUGS, JACKS AND PHONE TIPS
SUB-GROUP:	NON-INSULATED PHONE TIPS
DESCRIPTION:	NON-INSULATED PHONE TIP PLUG, THREAD MOUNT

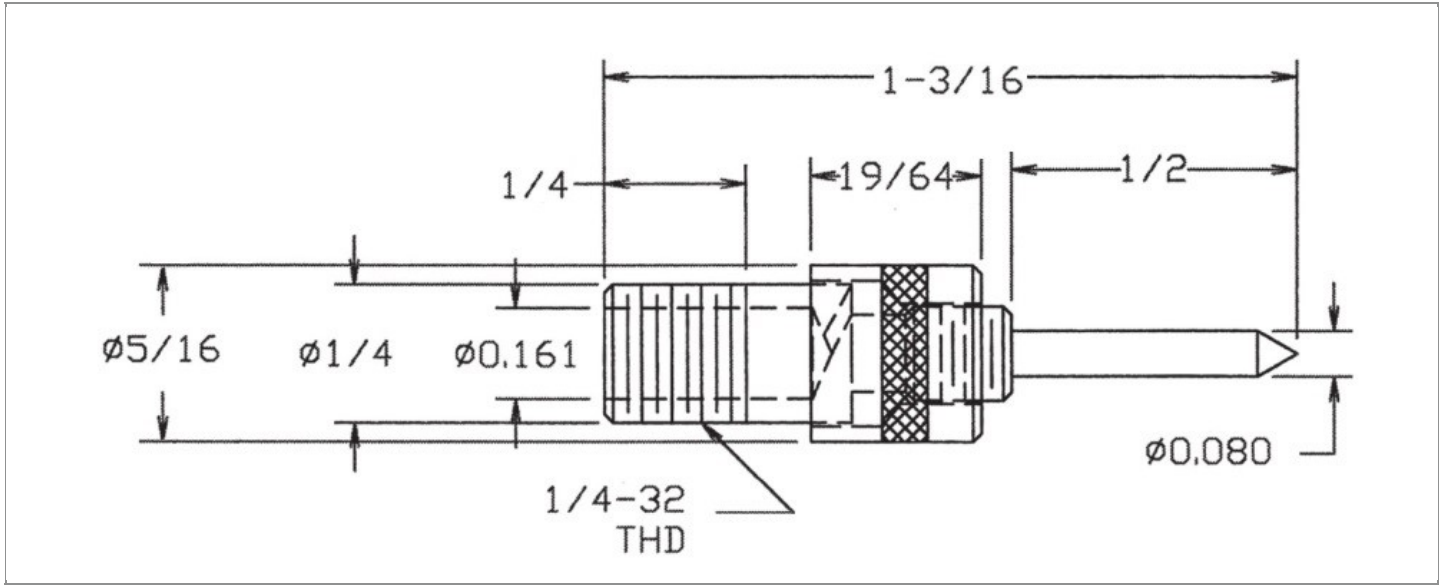

ACCEPTS PIN / PLUG / JACK SIZE	OVERALL LENGTH	PIN DIAMETER	MIN. HOLE DEPTH
STANDARD PHONE TIP JACK	1.188"	0.080"	0.370"

PART NO. STRUCTURE:

01-4105 - 1 - XX
 PART SERIES DIMENSION FINISH

MATERIAL OPTIONS:

01-4105-1-XX

COMPONENT	MATERIAL	MATERIAL AND SPECIFICATION
BODY	BRASS	BRASS PER ASTM B16, ALLOY C36000, 1/2 HARD

FINISH - PLATING OPTIONS:

01-4105-1-XX

FINISH CODE	COMPONENT	FINISH	FINISH AND SPECIFICATION
02	BODY	NICKEL	0.000100"MIN. NICKEL PER SAE-AMS-QQ-N-290

TOLERANCES:*

DECIMAL	FRACTIONAL	ANGULAR	DRAWING ORIGATION DATE	LAST MODIFICATION DATE
± 0.005	± 1/64	± 5°	9/10/1998	4/1/2017

*All dimensions are in inches.

RoHS COMPLIANCE:

01-4105-1-XX

PART NUMBER	RoHS COMPLIANT
01-4105-1-02	YES

NOTES:

DATASHEET NOTES

RATED: 12 AMPERES CONTINUOUS DUTY.

INSTRUCTION NOTES

WIRE IS INSERTED THRU REAR AND CROSS HOLES AND THEN WRAPPED AROUND PLUG BODY. 1/4-32 THREADED COLLAR TIGHTENS DOWN WIRE.
SUPPLIED WITH NICKEL PLATED BRASS 1/4-32 THREADED COLLAR.
